

B-2040 Jolly Pack pensilina

Nuova pensilina senza tiranti, con regolazione dell'inclinazione, con sede per LED.

New glass canopy without rods, adjustable, with channel for LED.

Neues Vordach System ohne Zugstange, verstellbar Inclination, mit Option für LED.

Unire minimo impatto estetico ed efficienza meccanica: questo l'obiettivo e il risultato ottenuto con la Pensilina Jollypack, che garantisce una resistenza eccezionale ai carichi, pur in assenza di supporti o tiranti.

Un profilo in alluminio studiato appositamente per permettere una salda presa del vetro e una tenuta solidissima una volta fissato al muro, sono il segreto di questa soluzione assolutamente innovativa. La sezione del profilo è studiata in modo tale da accogliere vetri di diverso spessore e consentendo angoli di inclinazione diversi per lo scarico della pioggia.

Il risultato estetico è da vedere: estrema pulizia e assoluta linearità del disegno, fanno in modo che il vetro sembri sospeso al muro per virtù propria. Questa è la magia della ricerca tecnologica che sta alla base della Pensilina Jollypack.

The aim was to bring together cosmetic impact and mechanical efficiency and this was achieved with the Jollypack Canopy, which guarantees an exceptional level of resistance to loads even though there are no supports or stay rods.

The secret of this highly innovative solution is an aluminium frame that has been especially designed to have a strong grip on the glass and to give a very firm hold once it is fixed to the wall. The frame's section is designed to hold glass of various thicknesses and make various inclination angles possible to drain off rain. The cosmetic result is unmissable; extremely clean and a design that is absolutely linear making the glass seem attached to the wall on its own. This is the magic of the technical research that is the foundation of the Jollypack Canopy.

Geringe Beeinträchtigung der Optik kombiniert bei wirksamer Mechanik: das ist das Ziel und Ergebnis des Vordaches Jollypack, das trotz des Fehlens von Halterungen oder Zugstangen maximale Tragfähigkeit garantiert.

Ein eigens entwickeltes Alu-Profil, das eine sichere Glasaufnahme und einen perfekten Halt nach der Wandmontage garantiert, ist das Geheimnis dieser absolut innovativen Lösung. Der Profilquerschnitt wurde entwickelt, um Glasscheiben verschiedener Stärken aufzunehmen und verschiedene Neigungswinkel zur Regenablenkung zu ermöglichen.

Die Optik ist sehenswert: die klare Linien führen dazu, dass das Glas von allein an der Wand befestigt erscheint. Dies ist die Faszination der technologischen Forschungsarbeit, die hinter dem Vordach Jollypack steht.

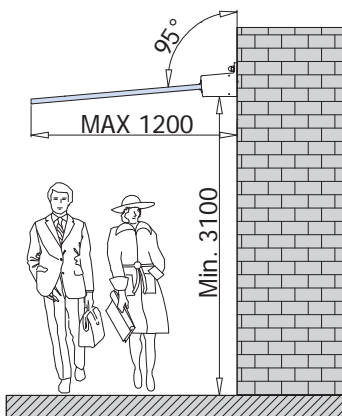



B-2040 Jolly Pack pensilina

Nuova pensilina senza tiranti, con regolazione dell'inclinazione, con sede per LED.
 New glass canopy without rods, adjustable, with channel for LED.
 Neues Vordach System ohne Zugstange, verstellbar Inclination, mit Option für LED.

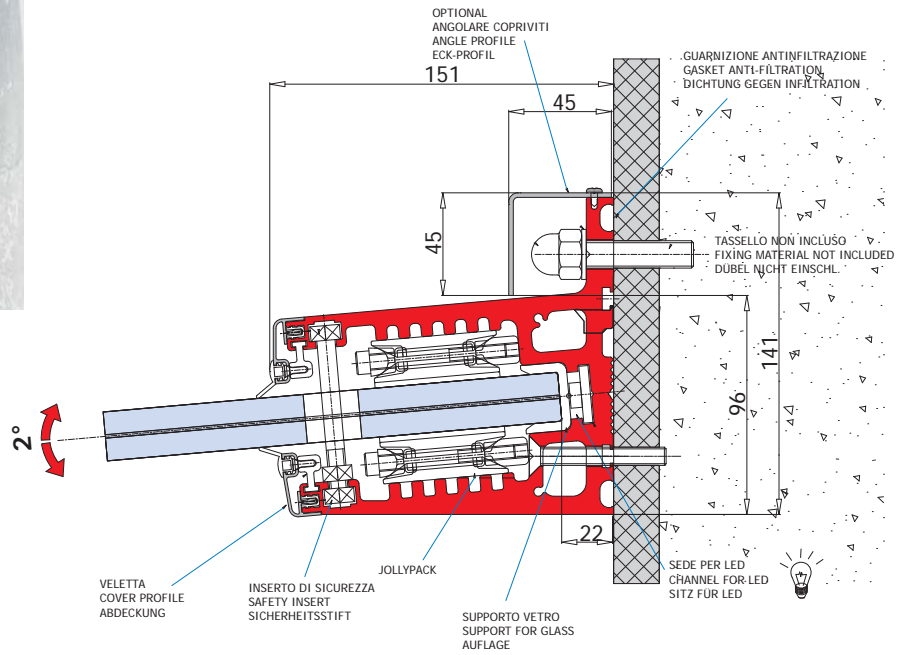

8 + 8
 10 + 10
 (p.vb 1,52)

Preparazione vetro
 Glass preparation
 Glasbearbeitung

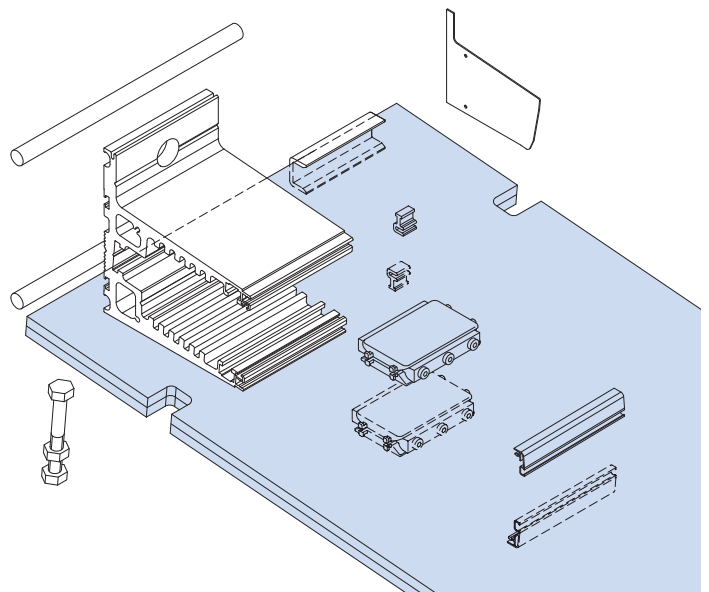
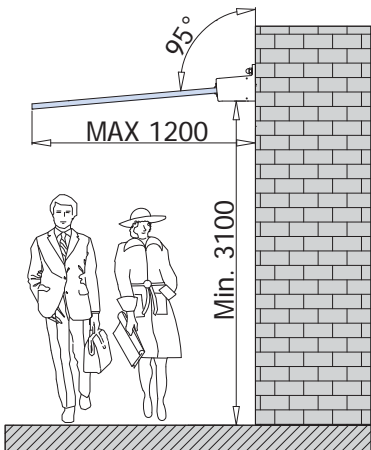
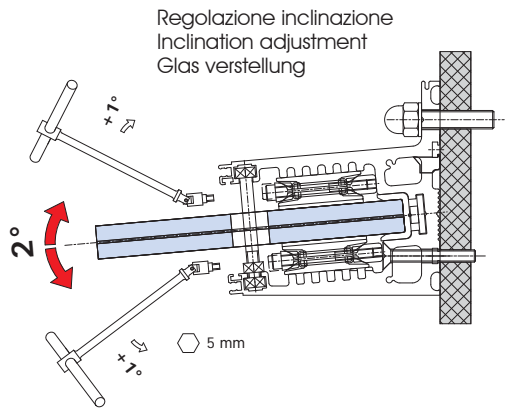
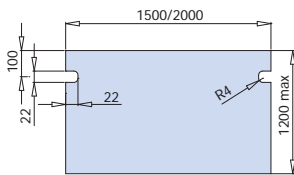
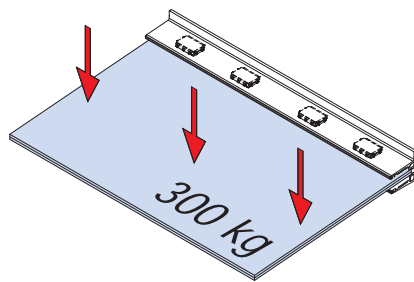



B-2040 set 1
JOLLY PACK SET 1



(N.8 pcs.)

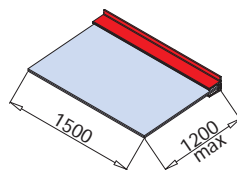

B-2040 set 2
JOLLY PACK SET 2



(N.10 pcs.)

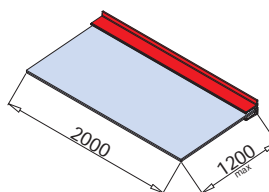

B-2040 set 3
JOLLY PACK SET 3



(N.20 pcs.)

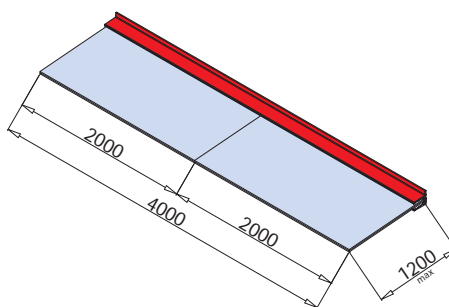

B-2040/B-2001

Profilo pensilina e velette
canopy profile with cover profiles
Vordach Profil mit Abdeckungen.

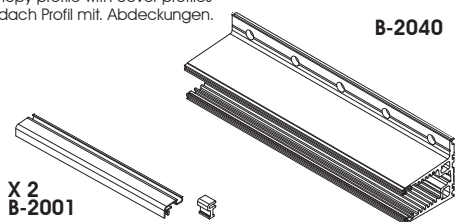

X 2
B-2001

B-2004 set

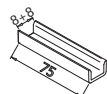

6 pcs



B-2005 set

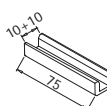

6 pcs



B-2002 set



12 pcs

B-2003 set



18 pcs

B-2041

Tappo di chiusura laterale
Endcap
Endkappe

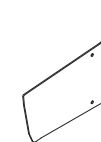

1 pcs